

COMPONENTI ATTIVI TELAIO

| | | |
|----------------|-------------|-----------------|
| STV8206 | SDP56 | DECOD. STEREO |
| TDA7286B | MULTIWATT15 | BF STEREO |
| TEA2281 | DP16 | SWITCH MODE |
| TEA2014A | DP8 | COMPUT. VIDEO |
| TSOP4385A1 90° | VISHAY | RIC. INFRAROSSI |
| STS5PF30L | S08 | COMUTATORE |
| LF120CDT | DPAK | STABILIZZ. 12V |
| SFH817A-2 | DP4 | OPTO |
| BU608AF | ISOWATT218 | FINALE SWITCH |
| BC807 | SOT23 | TRANSISTORE |
| BC847 | SOT23 | TRANSISTORE |

TUNER - TELECOMANDO

| | | |
|----------|--------|-----------------|
| TDA6405 | SSOP28 | OSCLL. PLL |
| TDA9885 | SSOP24 | MEDIA FREQUENZA |
| M3004LTD | S020 | TRASH. TELEC. |
| BC817 | SOT23 | TRANSISTORE |
| BC847BW | SOT23 | TRANSISTORE |
| BF1005S | SOT143 | MOSFET I2I |

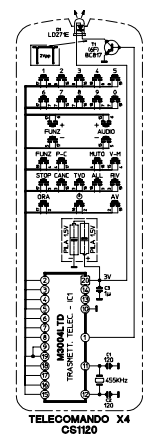
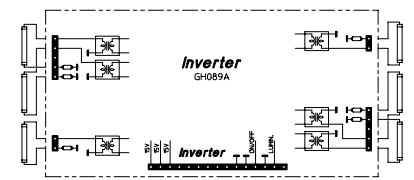

COMPONENTI ATTIVI

| | | |
|-----------------|---------|---------------------|
| STV3550B | POFF208 | MICROP.-SCALER |
| STV2310D | TSOP44 | CROMA |
| M29KW032E | TSOP48 | MEM. FLASH |
| K45281932C-T076 | S4T50P2 | MEM. SDRAM |
| M24C04WMN6 | S08 | MEMORIA EPROM |
| STS5PF30L | S08 | COMUTATORE |
| TS831-3D | S08 | RESET |
| LD1117DT18 | DPAK | STABILIZZ. 1.8V (2) |
| LD1088D2T33 | D2PAK | STABILIZZ. 3.3V (2) |
| BC847 | SOT23 | TRANSISTORE |

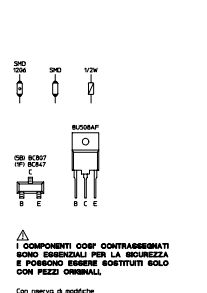
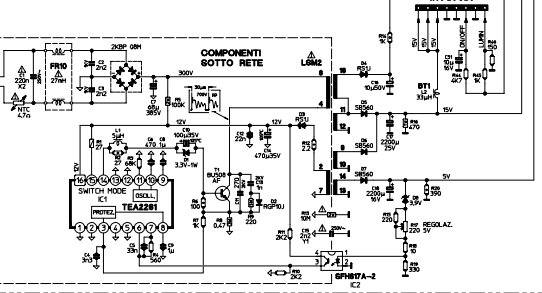
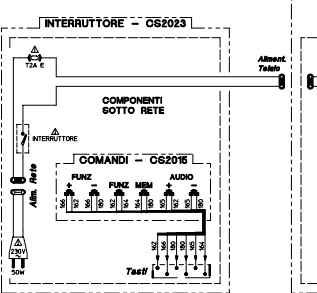
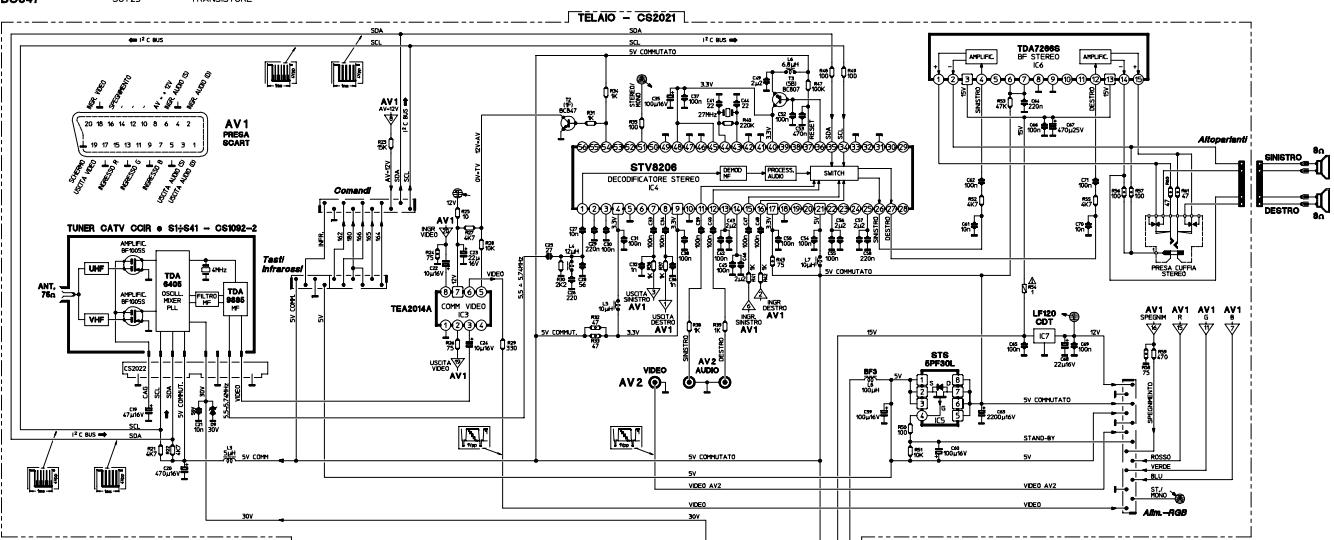

I COMPONENTI CONF. CONTRASSEGNA TI SONO ESSENZIALI PER LA SICUREZZA E POSSONO ESSERE SOSTITUITI SOLO CON PEZZI ORIGINALI.
Con riserva di modifiche

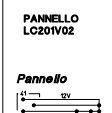
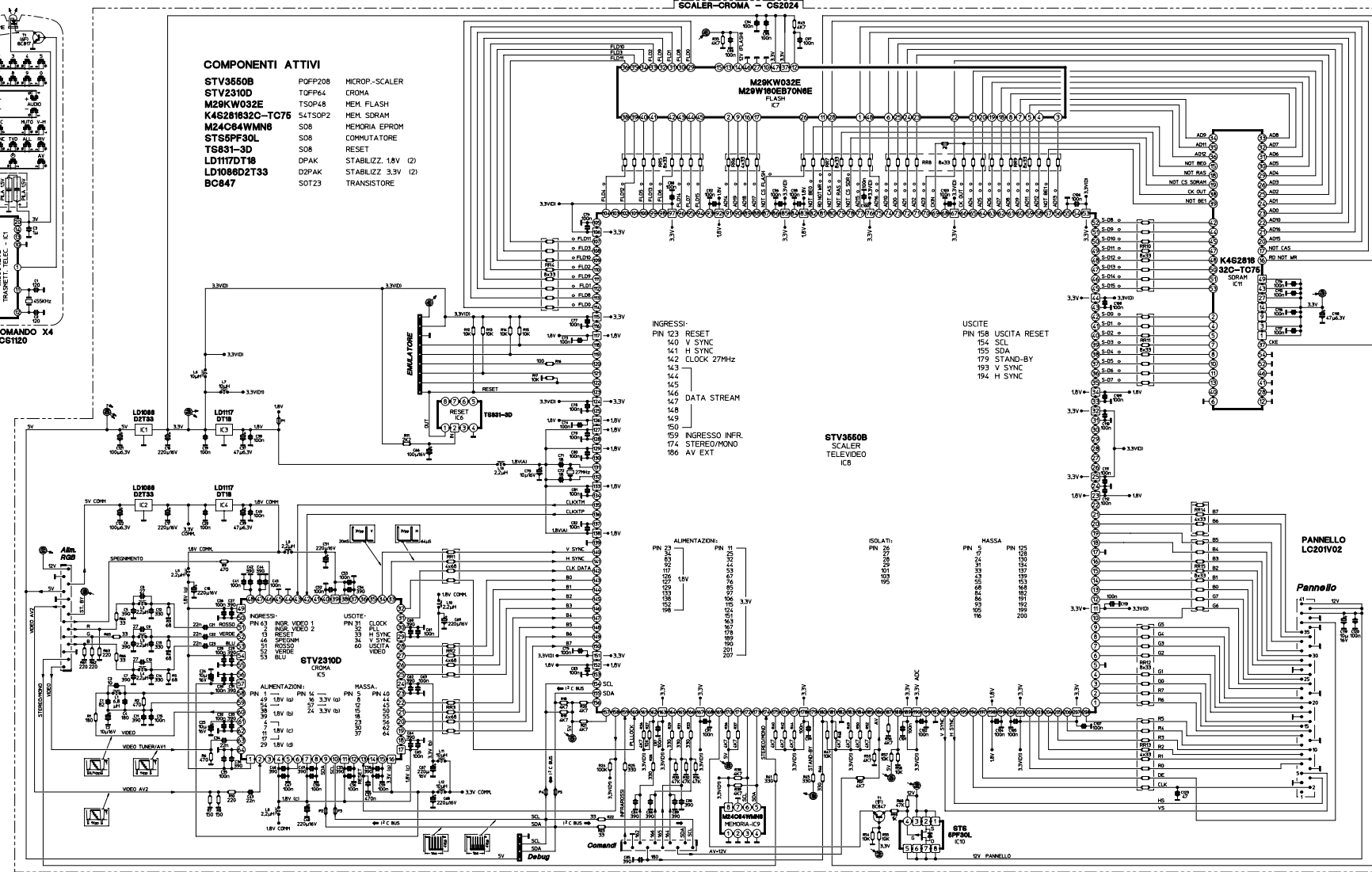

Pannello